	NATIONAL FOOD PRODUCTS CO.		CODE: PLA/QAD/DS -3
	QUALITY SYSTEM FORMS		ISSUE DATE: 10-June-2017
	Product Data Sheet Thermoforming		ISSUE NO.: 4
	Code	ULD5168HCIN150-1000	PAGE: 1/1

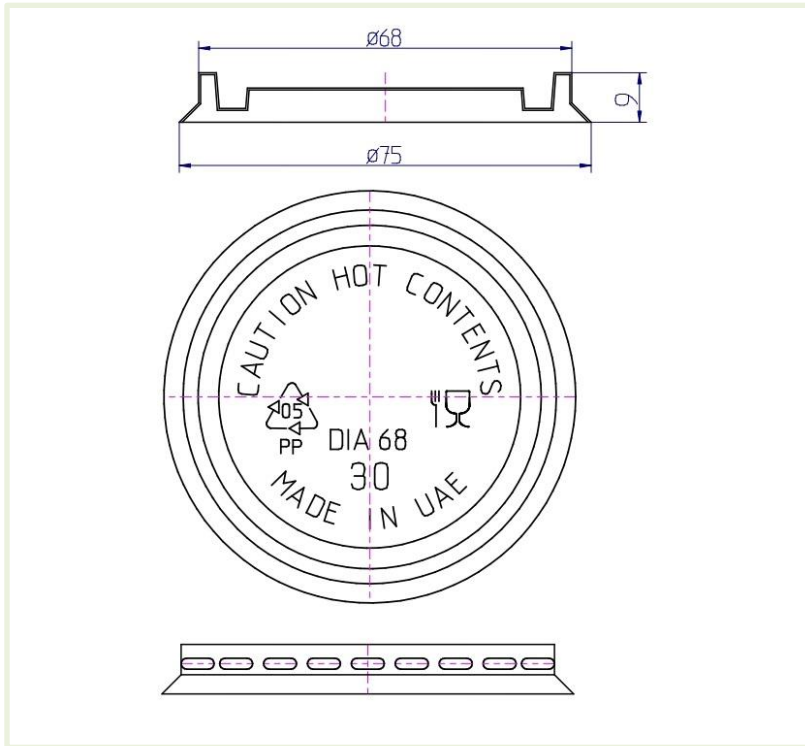

Item	PP PAPER CUP LID 68D HCL
Material:	Polypropylene
Color	Half Clear
Unit Weight:	1.5 g ± 0.2g

Quantity	1000 Pcs. /Carton
Carton Size	40.5 X 26 X 32.5 cm

Dimensions in "mm" (Not to scale)

Issued by: QC MPC